

How To Recover A Pool Table - Felt Installation and Replacement Guide

How to recover a pool table? This pool table felt installation and replacement guide will show you how to install new felt and recover your pool table. Replacing the felt on your pool table is not a difficult job but requires a few basic instructions on the pool table felt installation process. The instructions below will greatly increase your chances for success.

ATTACHING CLOTH TO TABLE

When covering tables, first clean the table thoroughly, then check the slate for level and shim where required. Make sure the screws are fully tightened. Then grout the joints with a flexible filler such as beeswax. Do not use paraffin or plaster of paris.

1.

Leave only enough cloth for one end of slate and one side (location 1) to allow stapling into the wood frame in 3 places, approximately 2" apart.

2.

Stretch cloth tightly across table and staple three places at (location 2) 2" apart.

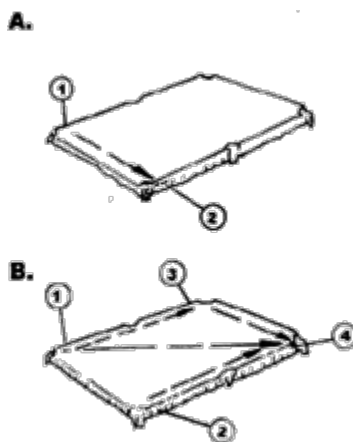

3.

Stretch the cloth tightly from (1) to (3) and staple three places into wood frame 2" apart.

4.

Stretching cloth tightly across table from (3) and pulling from (2), staple two places at (4).

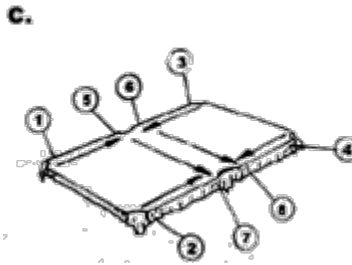

5.

Stretch cloth tightly from (1) toward side pocket (5) and staple three places.

6.

Repeat step 5, stretching from from location (3) and staple at location (6).

7.

Stretch cloth tightly across the table from (5) and toward side pocket (7) from (2) and staple at location (7).

8.

Repeat step 7, stretching cloth from (6) and toward the side pocket at (8).

NOTE: At the side pockets there may be a small pucker at the center. This will disappear in step 17.

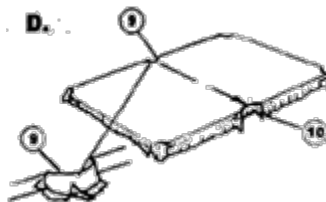

9.

At (9), cut a short slit in cloth at the edge - centered on the side pocket opening. Grasp cloth firmly above the slit, pull the cloth in to the side pocket opening and staple to the underside of the frame while working out any wrinkles.

10.

Stretching cloth tightly across the table from (9), repeat above step at (10).

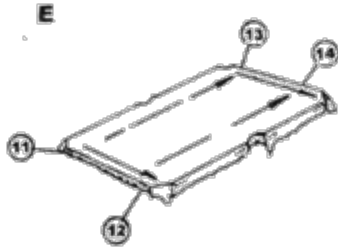

11.

Staple cloth at (11) leaving a little slack at the corner pocket opening.

12.

Pull cloth tightly from (11) to (12) and staple three places at (12).

13.

Stretch cloth tightly from (11) to (13) and staple on approximately 3" centers.

14.

Stretch cloth tightly from (12) and (13) toward (14), and staple in three places at (14).

15.

Staple cloth on approximately 3" centers on each side (1) and (3).

16.

Stretch balance of the cloth across the table from (11) to (12) and staple.

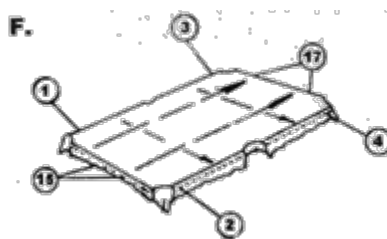

17.

Stretch cloth tightly down the length of the table from location (15) assuring that the slight pucker at the side of the pockets has disappeared - staple securely.

18.

Stretch cloth tightly across the table at each side of the center pockets and staple on approximately 3" centers.

19.

Stretch the cloth into the corner pockets and staple to the underside of the slate frame. If necessary cut short slits in the edge of the cloth to assure there are no wrinkles.

20.

Trim off all excess cloth around the table.

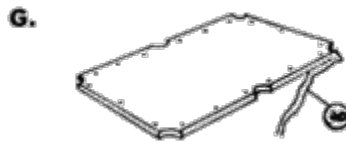

REPLACING RAIL CLOTH (Pocket Tables)

A. Preparing Old Rails

1.

After removing the rails from the table, remove the staples from the ends of the rails at the rear edge of the pocket facing

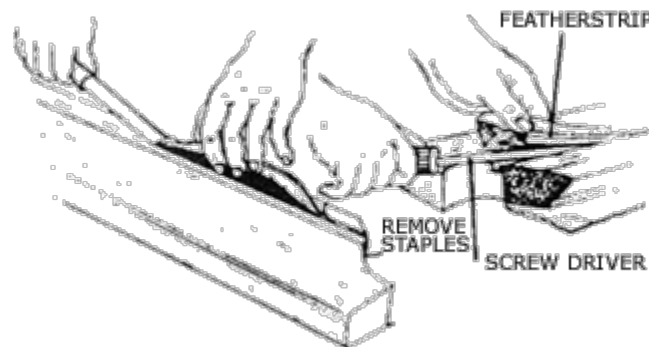

figure 1-A figure 1-B

2.

Cut the old cushion cloth along the full length of featherstrip on the cushion side (approximately 1/2" from the cloth line) as shown in figure 1A.

3.

Peel the cloth down and insert a featherstrip puller or flat blade screwdriver (not over 1/8" wide) beneath the featherstrip (as shown in Figure 1B), and carefully pry the featherstrip

out of the groove. If the featherstrip is undamaged save it for reuse. Turn rail face side down and remove the staples from the old cloth.

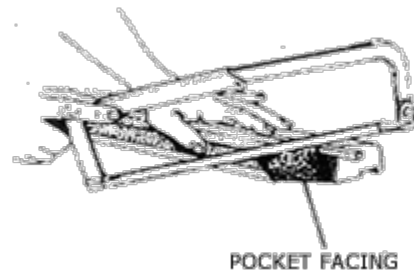

figure b

B. Installing Featherstrips

1.

If installing new featherstrips, place the featherstrip in the groove as shown in Figure B and trim one end flush with the angle of the pocket opening with a hacksaw. Be careful to keep the blade tilted at a sufficient angle so you don't cut into the rail pocket area behind the featherstrip.

2.

With one end trimmed, place that end down in to the featherstrip groove and "butt" it flush against the pocket facing - then trim the other end in the same manner.

3.

Place the new cloth over the featherstrip groove and check to see if the featherstrip will tap down into the groove. If the cloth is of heavier grade the featherstrip may require planing as shown in Figure C.

The groove in the top rail and the featherstrip are cut for lighter grade cloth. To allow for a full range of cloth grades, removing material from the featherstrip may be required.

C. Attaching Cloth - Pocket Tables

Corner Pockets

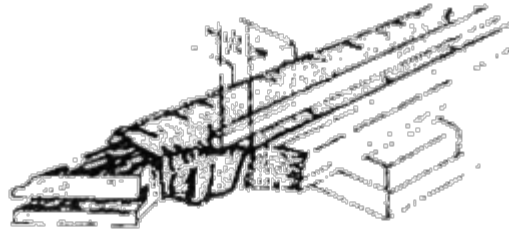

figure 1

1.

Place the new cloth on the rail with the nap side down. With the nap of the cloth from the left to the right on the end rails, or from designated head to foot of the table on side rails. The cloth should have an equal amount of overhang at both ends of the rail and extend 1/2" over the featherstrip groove on the cushion side as shown in Figure 1.

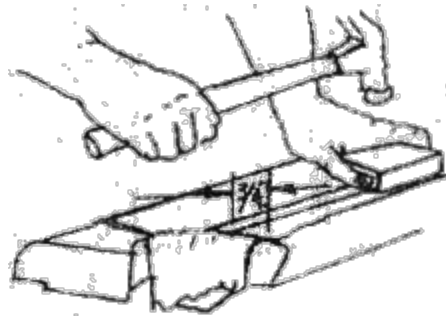

figure 2

2.

Except for approximately 3" at the end of the rail, tap the featherstrip down with the tapping block and hammer as shown in Figure 2.

3.

At each end of the rails pull the cloth toward the rubber cushion an additional 3/4" then tap the remainder of the featherstrip down (Figure 2).

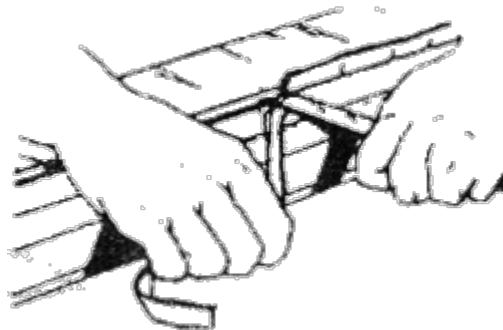

figure 3

4.

Trim the cloth on the cushion side of the featherstrip along the total length of the featherstrip as shown in Figure 3.

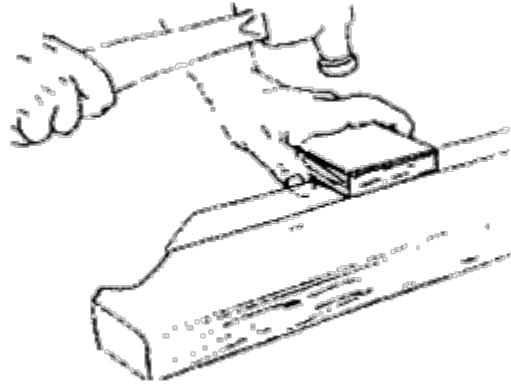

figure 4

5.

Fold the cloth down over the front of the rail then use your thumb and forefinger as a guide along the front edge of the cushion to keep the tapping block at the rear edge of the featherstrip - tap the featherstrip down flush with the rail surface as shown in Figure 4.

Never try to tap a featherstrip flush with just a hammer as it will certainly dent the rail surface behind the feather strip.

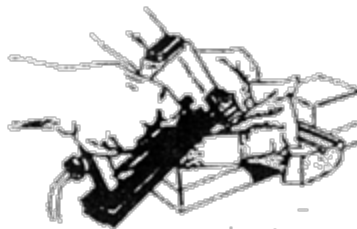

figure 5

6.

Turn the rail over and at the corner pockets fold the cloth over the mitered edge as shown in Figure 5. Stretch the cloth tightly, work out any wrinkles as you staple three places in the area shown in Figure 5.

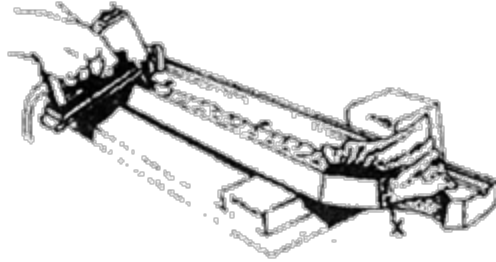

figure 6

7.

Staple three places along the rear edge of the pocket facing ("X" in Figure 6), then trim off the superfluous cloth at the pocket area.

8.

If the rail is an end rail repeat Step 7 at the other corner pocket then, starting at the center of the rail, stretch the cloth tightly over the cushion and staple at the bottom of the rail working toward each end (Figure 6).

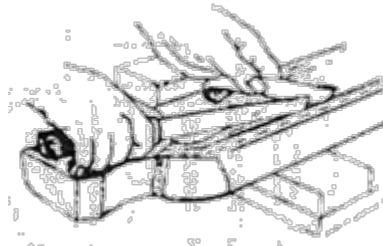

figure 7

9.

Trim the excess cloth from the bottom of the rail as shown in Figure 7 flush with the edge of the cloth relief groove.

Side Pockets

10.

At the side pocket stretch the cloth tightly over the nose of the cushion and staple in three places as shown in Figure A.

STAPLE 3 PLACES

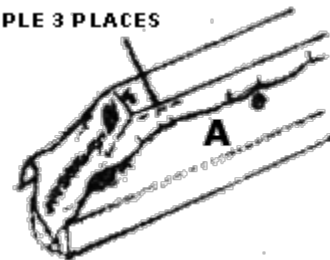

11.

Slit the cloth up the edge of the cushion nose as shown in Figure B, then firmly pull the small strip (Figure B) to the rear of the cushion and staple at the rear of the facing.

12.

Hold the small fold in place with your thumb and forefinger and firmly fold it down over the facing at the bottom of the rail as shown in Figure C.

13.

Trim any excess cloth as required.

